

Centre Number						Candidate Number				
Surname										
Other Names										
Candidate Signature										

For Examiner's Use	
Examiner's Initials	
Question	Mark
1	
2	
3	
4	
5	
6	
7	
TOTAL	



General Certificate of Secondary Education
Higher Tier
January 2013

Additional Science

Unit Biology B2

BL2HP

Biology

Unit Biology B2

H

Tuesday 22 January 2013 9.00 am to 10.00 am

For this paper you must have:

- a ruler.
- You may use a calculator.

Time allowed

- 1 hour

Instructions

- Use black ink or black ball-point pen.
- Fill in the boxes at the top of this page.
- Answer **all** questions.
- You must answer the questions in the spaces provided. Do not write outside the box around each page or on blank pages.
- Do all rough work in this book. Cross through any work you do not want to be marked.

Information

- The marks for questions are shown in brackets.
- The maximum mark for this paper is 60.
- You are expected to use a calculator where appropriate.
- You are reminded of the need for good English and clear presentation in your answers.
- Question 1(c) should be answered in continuous prose.
In this question you will be marked on your ability to:
 - use good English
 - organise information clearly
 - use specialist vocabulary where appropriate.

Advice

- In all calculations, show clearly how you work out your answer.



J A N 1 3 B L 2 H P 0 1

Answer **all** questions in the spaces provided.

- 1 Some students investigated the effect of light intensity on the rate of photosynthesis. They used the apparatus shown in **Diagram 1**.

Diagram 1

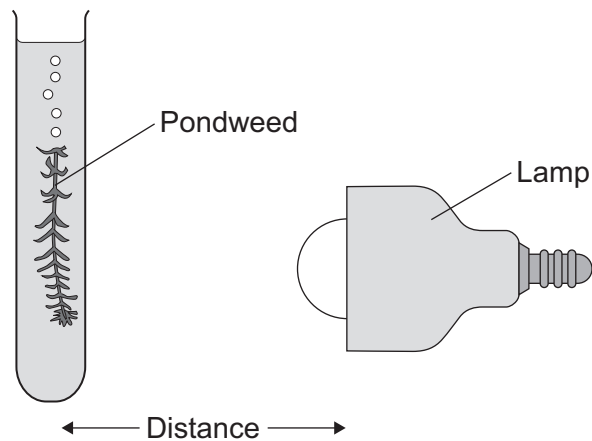

The students:

- placed the lamp 10cm from the pondweed
- counted the number of bubbles of gas released from the pondweed in 1 minute
- repeated this for different distances between the lamp and the pondweed.

- 1 (a) The lamp gives out heat as well as light.

What could the students do to make sure that heat from the lamp did **not** affect the rate of photosynthesis?

.....

.....

(1 mark)



1 (b) The table shows the students' results.

Distance in cm	Number of bubbles per minute
10	84
15	84
20	76
40	52
50	26

1 (b) (i) At distances between 15cm and 50cm, light was a limiting factor for photosynthesis.

What evidence is there for this in the table?

.....

.....

(1 mark)

1 (b) (ii) Give **one** factor that could have limited the rate of photosynthesis when the distance was between 10cm and 15cm.

.....

(1 mark)

Question 1 continues on the next page

Turn over ►



1 (c) *In this question you will be assessed on using good English, organising information clearly and using specialist terms where appropriate.*

Diagram 2 shows a section through a plant leaf.

Diagram 2

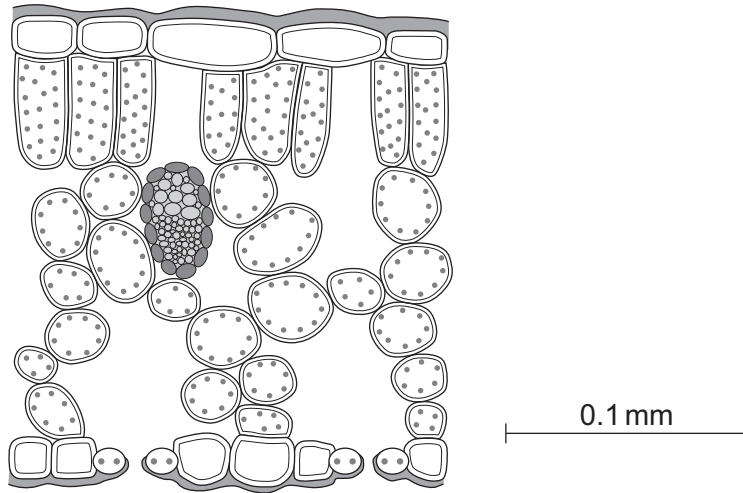

Describe the structure of the leaf and the functions of the tissues in the leaf.

You should use the names of the tissues in your answer.

.....

.....

.....

.....

.....

.....

.....

.....

.....

.....

.....

.....

.....

.....

.....



.....

.....

.....

.....

.....

(6 marks)

9

Turn over for the next question

Turn over ►



2 Trypsin is a protease enzyme. Trypsin will digest a protein called gelatine which covers the surface of photographic film.

Some students investigated the time taken to digest the gelatine with trypsin. The students used five different concentrations of trypsin.

The rate of reaction was calculated from the time taken for the gelatine to be digested.

The graph shows the students' results.

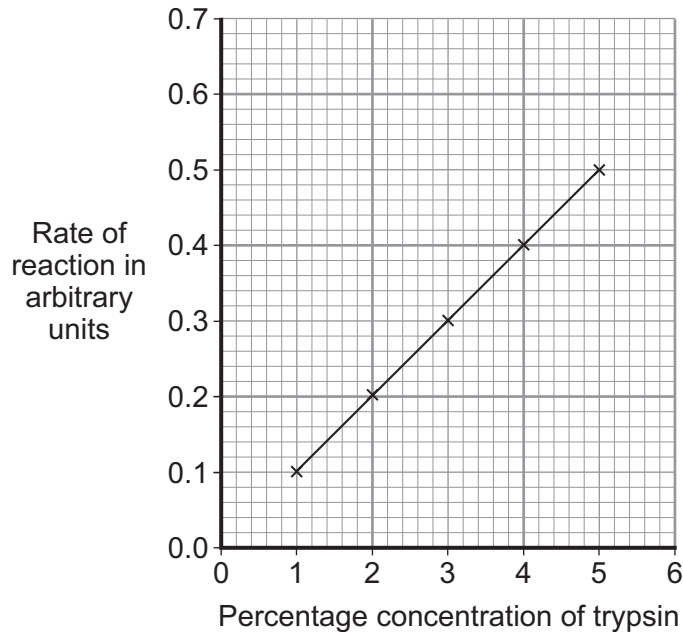

2 (a) (i) Describe the relationship between the concentration of trypsin and the rate of reaction.

.....

.....

.....

.....

(2 marks)

2 (a) (ii) Use the graph to predict the rate of reaction with 6% trypsin.

..... arbitrary units
(1 mark)



2 (b) In industry, trypsin is used to pre-treat some baby foods.
In their experiment, the students used 1–5% trypsin at 20°C.
The baby food manufacturers make most profit if they use 0.5% trypsin at 35°C.

Suggest why the manufacturers make most profit with these conditions.

.....
.....
.....
.....
.....
.....
.....
.....

(4 marks)

2 (c) (i) Describe the effect trypsin would have on the baby food.

.....
.....
.....
.....

(2 marks)

2 (c) (ii) Apart from protease enzymes, give **one** other use of a **named** enzyme in industry.

.....
.....
.....
.....

(2 marks)

11

Turn over ►



3 **Diagram 1** shows a cell from the pancreas.

Diagram 2 shows part of the cell seen under an electron microscope.

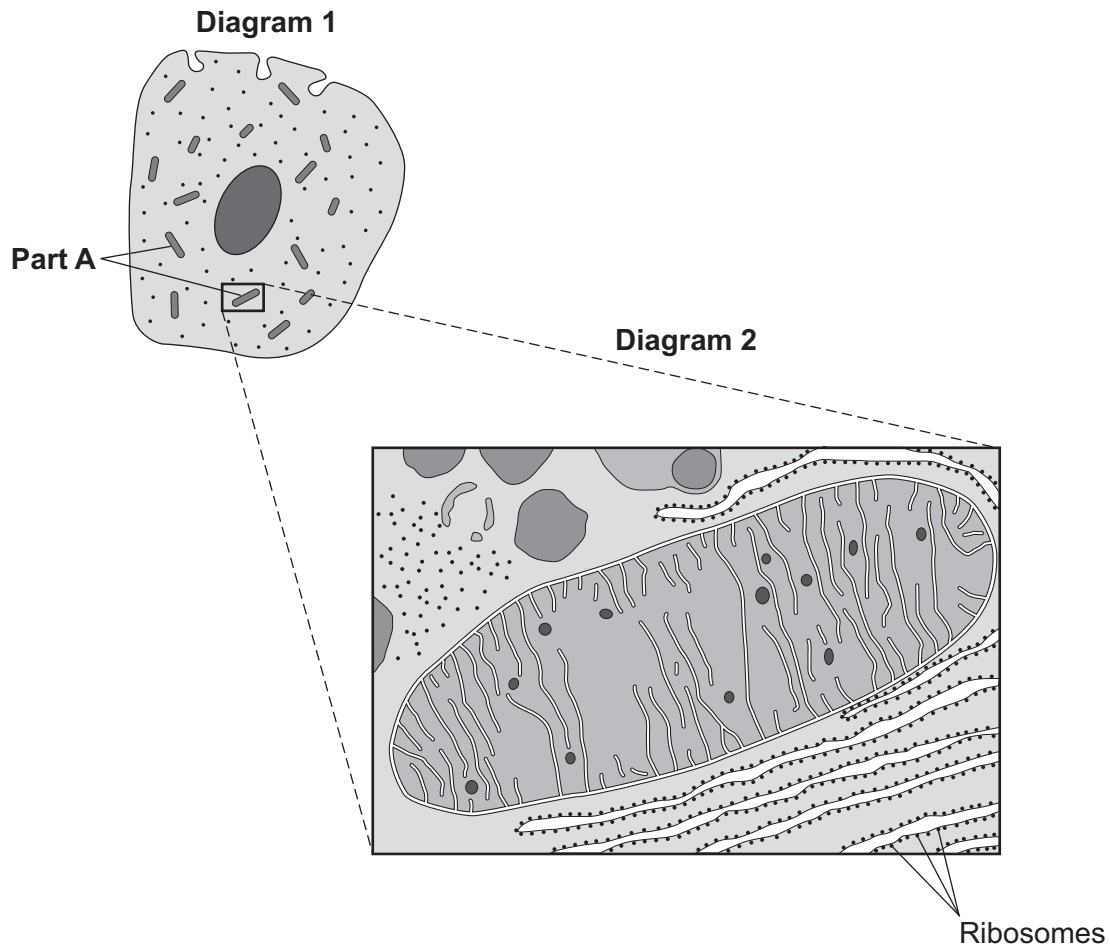

Part **A** is where most of the reactions of aerobic respiration happen.

3 (a) (i) Name part **A**.

.....

(1 mark)

3 (a) (ii) Complete the equation for aerobic respiration.

glucose + oxygen \longrightarrow + (+ energy)
(2 marks)



3 (a) (iii) Part **A** uses oxygen.

Explain how oxygen passes from the blood to part **A**.

.....

.....

.....

.....

.....

.....

.....

.....

(3 marks)

3 (b) The pancreas cell makes enzymes.

Enzymes are proteins.

Describe how the ribosomes and part **A** help the cell to make enzymes.

.....

.....

.....

.....

.....

.....

.....

.....

(3 marks)

9

Turn over ►



There are no questions printed on this page

**DO NOT WRITE ON THIS PAGE
ANSWER IN THE SPACES PROVIDED**



4 The diagram shows some of the cell divisions that occur during human reproduction.

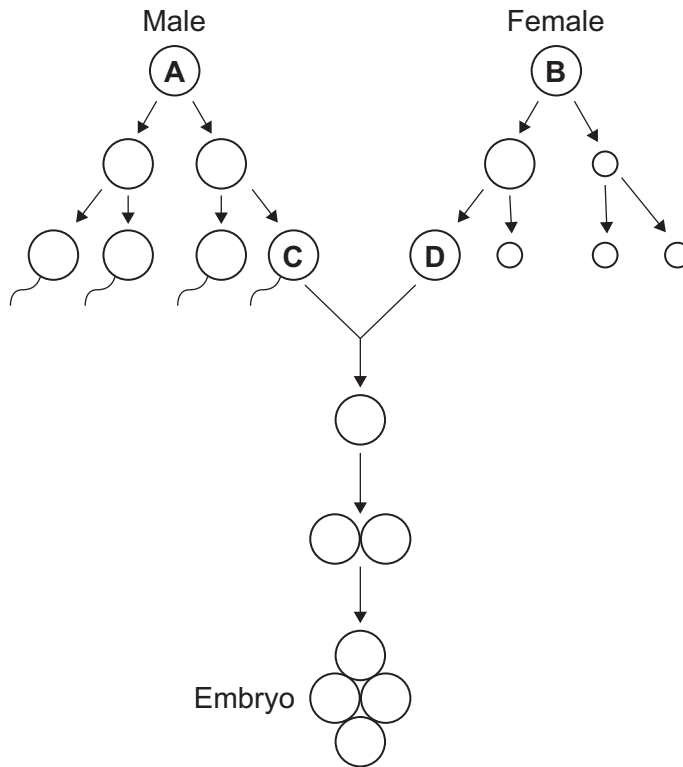

4 (a) (i) Name the type of cell division that produces cell D from cell B.

..... (1 mark)

4 (a) (ii) Which organ in the male body produces cell C from cell A?

..... (1 mark)

4 (b) (i) Cells A and B each contain 46 chromosomes.

How many chromosomes would there be in the nucleus of cell C?

(1 mark)

4 (b) (ii) Why is it important that cell C has this number of chromosomes?

.....

(2 marks)

5

Turn over ►



5 Some students studied bluebell plants growing in two different habitats.

Habitat **A** was a sunny field next to woodland.

Habitat **B** was a shady, moist woodland.

A bluebell plant can have several flowers on one flower stalk. The students counted the number of flowers on each of 40 bluebell flower stalks growing in each habitat. The bar charts show the results.

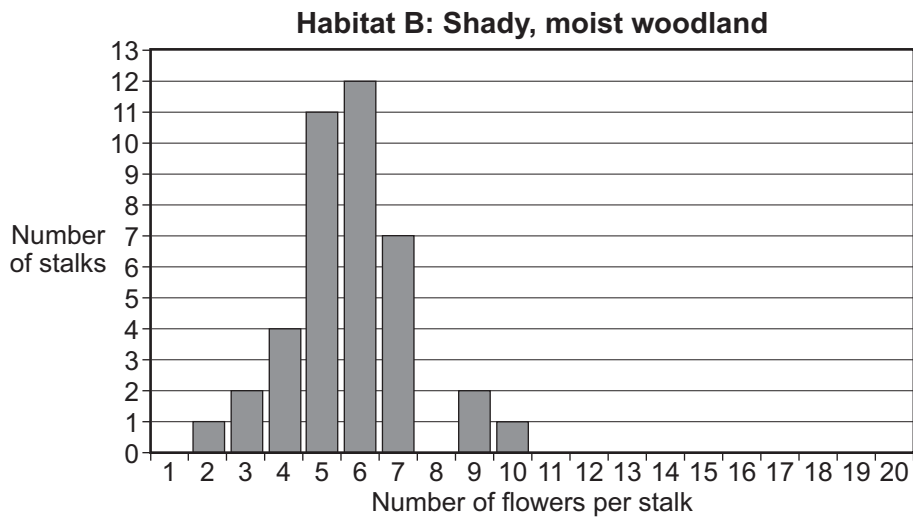
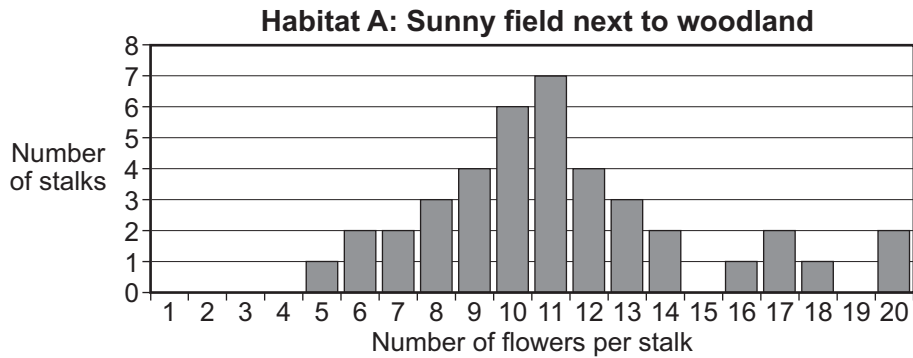

5 (a) The students wanted to collect valid data.

Describe how the students should have sampled the bluebell plants at each habitat to collect valid data.

.....

.....

.....

.....

.....

(2 marks)



5 (b) (i) The students used the bar charts to find the mode for the number of flowers per stalk in the two habitats.

The mode for the number of flowers per stalk in habitat **A** was 11.

What was the mode for the number of flowers per stalk in habitat **B**?

Mode =
(1 mark)

5 (b) (ii) The students suggested the following hypothesis:

‘The difference in the modes is due to the plants receiving different amounts of sunlight.’

Suggest why.

.....
.....
.....
.....
(2 marks)

5 (b) (iii) Suggest how the students could test their hypothesis for the two habitats.

.....
.....
.....
.....
(2 marks)

5 (c) Suggest how receiving more sunlight could result in the plants producing more flowers per stalk.

.....
.....
.....
.....
(2 marks)

9

Turn over ►



6 CADASIL is an inherited disorder caused by a dominant allele.
 CADASIL leads to weakening of blood vessels in the brain.
 The diagram shows the inheritance of CADASIL in one family.

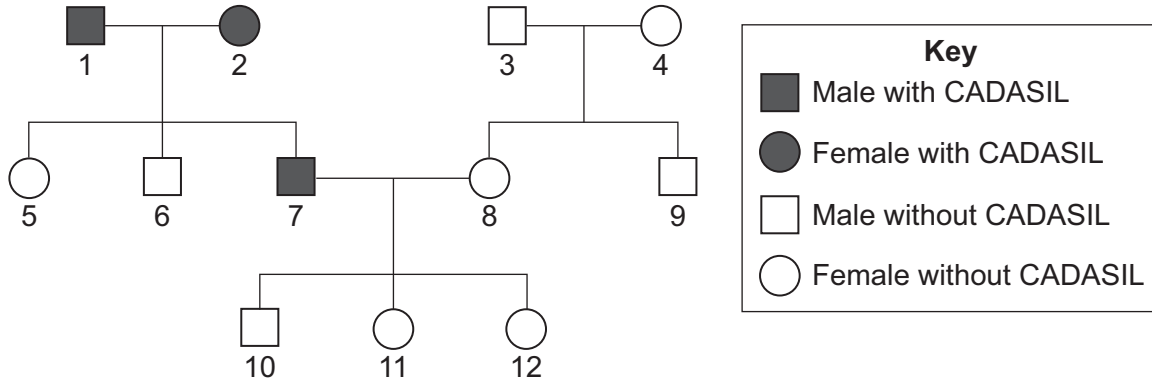

6 (a) CADASIL is caused by a *dominant allele*.

6 (a) (i) What is a *dominant allele*?

.....

 (1 mark)

6 (a) (ii) What is the evidence in the diagram that CADASIL is caused by a dominant allele?

.....

 (1 mark)

6 (a) (iii) Person 7 has CADASIL.

Is person 7 homozygous or heterozygous for the CADASIL allele?

Give evidence for your answer from the diagram.

.....

 (1 mark)



6 (b) Persons **7** and **8** are planning to have another baby. Use a genetic diagram to find the probability that the new baby will develop into a person with CADASIL.

Use the following symbols to represent alleles.

- D** = allele for CADASIL
- d** = allele for not having CADASIL

Probability =
(4 marks)

6 (c) Scientists are trying to develop a treatment for CADASIL using stem cells. Specially treated stem cells would be injected into the damaged part of the brain.

6 (c) (i) Why do the scientists use stem cells?

.....

.....

.....

.....

(2 marks)

6 (c) (ii) Embryonic stem cells can be obtained by removing a few cells from a human embryo. In 2006, scientists in Japan discovered how to change adult skin cells into stem cells. Suggest **one** advantage of using stem cells from adult skin cells.

.....

.....

(1 mark)

10

Turn over ►



7 *Howea forsteriana* and *Howea belmoreana* are two species of palm tree.

The two *species* grow together on a small island in the South Pacific.

7 (a) What is meant by the term *species*?

.....

.....

.....

.....

(2 marks)



7 (b) The table gives some information about these two species of palm tree.

	<i>Howea forsteriana</i>	<i>Howea belmoreana</i>
Optimum pH of the soil for growth of the palm tree	pH 8	pH 6
Height above sea level of most common habitat	30 to 60 metres	above 120 metres
Month when most palm trees flower	October	December
Method of pollination	Wind carries pollen	Wind carries pollen

Scientists believe that these two species of palm tree began to evolve from a single species over 2 million years ago.

Suggest how these two different species developed.

In your answer you should use information from the table and your own knowledge.

.....

.....

.....

.....

.....

.....

.....

.....

.....

.....

.....

.....

.....

.....

.....

.....

.....

.....

.....

.....

.....

.....

.....

(5 marks)

7

END OF QUESTIONS



There are no questions printed on this page

**DO NOT WRITE ON THIS PAGE
ANSWER IN THE SPACES PROVIDED**



There are no questions printed on this page

**DO NOT WRITE ON THIS PAGE
ANSWER IN THE SPACES PROVIDED**



There are no questions printed on this page

**DO NOT WRITE ON THIS PAGE
ANSWER IN THE SPACES PROVIDED**

