

Centre Number						Candidate Number				
Surname										
Other Names										
Candidate Signature										

For Examiner's Use	
Examiner's Initials	
Question	Mark
1	
2	
3	
4	
5	
6	
7	
8	
TOTAL	



General Certificate of Secondary Education
Foundation Tier
June 2013

Additional Science

Unit Physics P2

Physics

Unit Physics P2

PH2FP

F

Thursday 23 May 2013 9.00 am to 10.00 am

For this paper you must have:

- a ruler
- a calculator
- the Physics Equations Sheet (enclosed).

Time allowed

- 1 hour

Instructions

- Use black ink or black ball-point pen.
- Fill in the boxes at the top of this page.
- Answer **all** questions.
- You must answer the questions in the spaces provided. Do not write outside the box around each page or on blank pages.
- Do all rough work in this book. Cross through any work you do not want to be marked.

Information

- The marks for questions are shown in brackets.
- The maximum mark for this paper is 60.
- You are expected to use a calculator where appropriate.
- You are reminded of the need for good English and clear presentation in your answers.
- Question 8 (b) should be answered in continuous prose. In this question you will be marked on your ability to:
 - use good English
 - organise information clearly
 - use specialist vocabulary where appropriate.

Advice

- In all calculations, show clearly how you work out your answer.



J U N 1 3 P H 2 F P 0 1

G/K91103 6/6/6/6/6

PH2FP

Answer **all** questions in the spaces provided.

- 1 (a)** The names of three types of radiation are given in **List A**. Some properties of these three types of radiation are given in **List B**.

Draw **one** line from each type of radiation in **List A** to its correct property in **List B**.

List A
Type of radiation

alpha

beta

gamma

List B
Property of radiation

will pass through paper but is stopped by thin metal

has the shortest range in air

will not harm human cells

is very weakly ionising

(3 marks)

- 1 (b)** The radioactive isotope iodine-123 can be used by a doctor to examine the thyroid gland of a patient. The iodine, taken as a tablet, is absorbed by the thyroid gland. The gamma radiation emitted as the iodine atoms decay is detected outside the body.

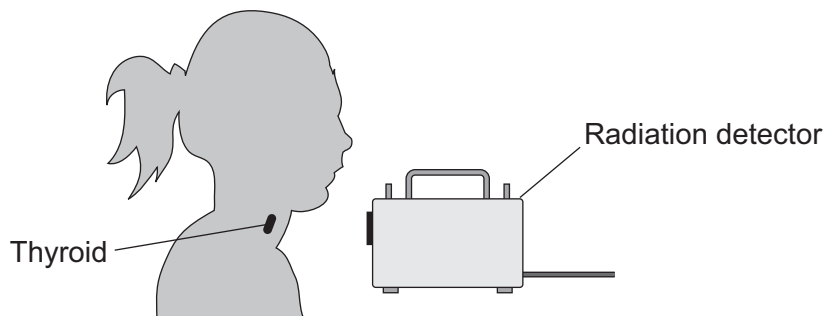

The doctor uses an isotope emitting gamma radiation to examine the thyroid gland rather than an isotope emitting alpha or beta radiation.

Which **one** of the following gives a reason why gamma radiation is used?

Tick (✓) **one** box.

Gamma radiation will pass through the body.

Gamma radiation is not deflected by a magnet.

Gamma radiation has a long range in air.

(1 mark)



1 (c) Iodine-123 has a half-life of 13 hours.

Use a word from the box to complete the sentence.

all	half	most
------------	-------------	-------------

After 13 hours of the iodine-123 atoms the thyroid absorbed have decayed.

(1 mark)

1 (d) Iodine-123 and iodine-131 are two of the isotopes of iodine.

Draw a ring around the correct answer to complete the sentence.

The nucleus of an iodine-123 atom has the same number of

electrons

neutrons

as the

protons

nucleus of an iodine-131 atom.

(1 mark)

6

Turn over for the next question

Turn over ►



3 (a) The diagram shows the inside of a three-pin plug.

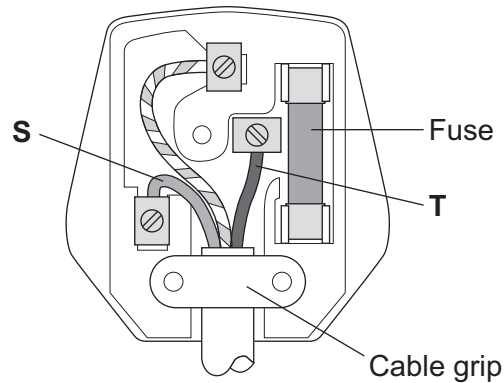

3 (a) (i) What name is given to the wire labelled **S**?

Draw a ring around the correct answer.

earth **live** **neutral**

(1 mark)

3 (a) (ii) What is the colour of the insulation around the wire labelled **T**?

Draw a ring around the correct answer.

blue **brown** **green and yellow**

(1 mark)

3 (b) The plug contains a 13 amp fuse.

3 (b) (i) Which **one** of the following is the correct circuit symbol for a fuse?

Draw a ring around the correct answer.

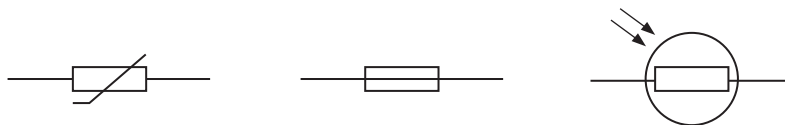

(1 mark)

Question 3 continues on the next page

Turn over ►



3 (b) (ii) The diagram shows the parts of the fuse.

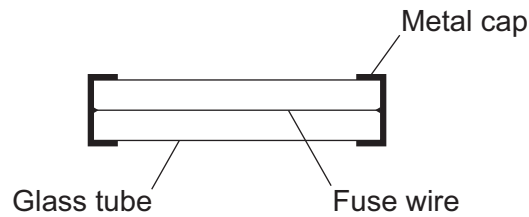

What would happen if a current of 20 amps passed through the 13 amp fuse?

.....

(1 mark)

3 (c) Not all electrical appliances are earthed.

3 (c) (i) Which **one** of the following appliances must be earthed?

Tick (✓) **one** box.

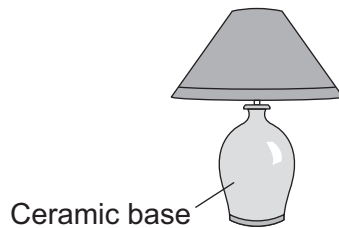
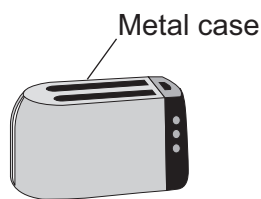
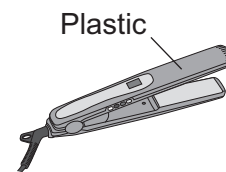

Table lamp



Toaster



Hair straighteners

Give a reason for your answer.

.....

(2 marks)

3 (c) (ii) Earthing an appliance helps to protect a person against a possible risk.

What is the risk?

.....

(1 mark)



3 (d) The diagrams show how two lengths of mains electrical cable were joined. The individual wires have been twisted together and covered with insulating tape. This is not a safe way to join the cables.

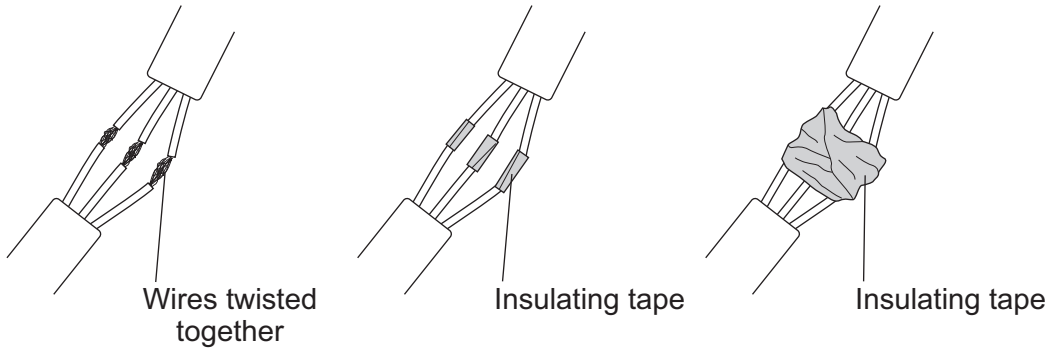

What is the possible risk from joining the two lengths of mains electrical cable in this way?

.....

.....

(1 mark)

3 (e) The diagram below shows a connecting box being used to join two lengths of electrical cable. This is a safe way to join the cables.

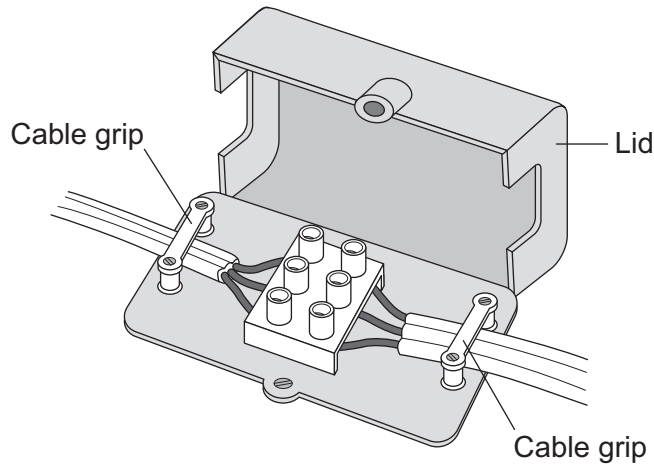

The cable grips are important parts of the connecting box.

Explain why.

.....

.....

.....

.....

(2 marks)

10

Turn over ►



4 The diagram shows a climber part way up a cliff.

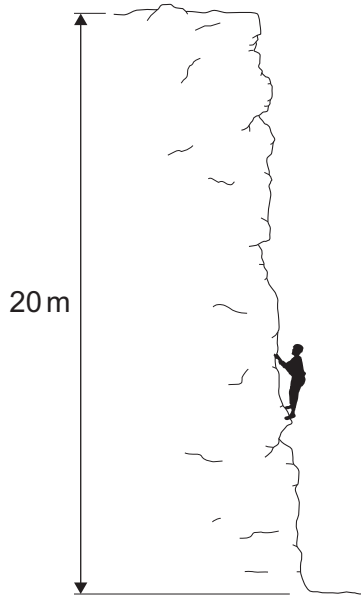

4 (a) Complete the sentence.

When the climber moves up the cliff, the climber gains gravitational energy.

(1 mark)

4 (b) The climber weighs 660 N.

4 (b) (i) Calculate the work the climber must do against gravity, to climb to the top of the cliff.

Use the correct equation from the Physics Equations Sheet.

.....

Work done = J
 (2 marks)

4 (b) (ii) It takes the climber 800 seconds to climb to the top of the cliff. During this time the energy transferred to the climber equals the work done by the climber.

Calculate the power of the climber during the climb.

Use the correct equation from the Physics Equations Sheet.

.....

Power = W
 (2 marks)

5



5 Nuclear power stations use the energy released from nuclear fuels to generate electricity.

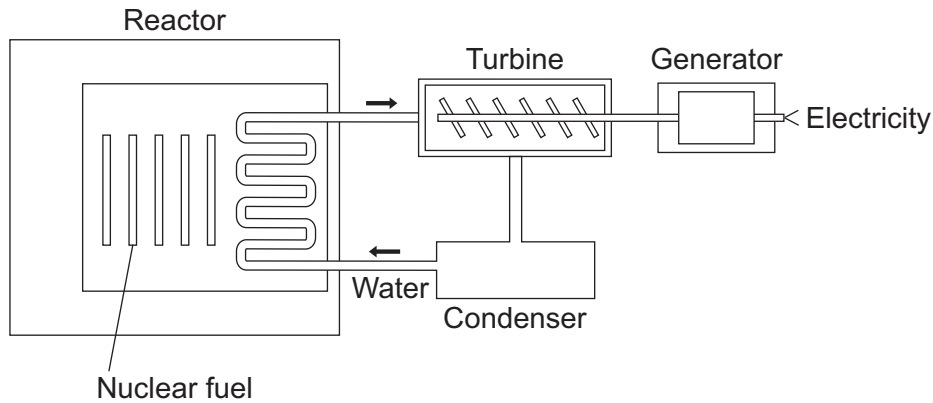

5 (a) Which substance do the majority of nuclear reactors use as fuel?

Draw a ring around your answer.

plutonium-239

thorium-232

uranium-235

(1 mark)

5 (b) Energy is released from nuclear fuels by the process of nuclear fission.

Describe what happens to the nucleus of an atom during nuclear fission.

.....

.....

.....

.....

(2 marks)

5 (c) Use words from the box to complete each sentence.

condenser	gas	generator	reactor	steam	turbine
-----------	-----	-----------	---------	-------	---------

The energy released from the nuclear fuel is used to heat water. The water turns into and this is used to drive a

This turns a to produce electricity.

(3 marks)

6

Turn over ►



6 The diagram shows how the thinking distance and braking distance of a car add together to give the stopping distance of the car.

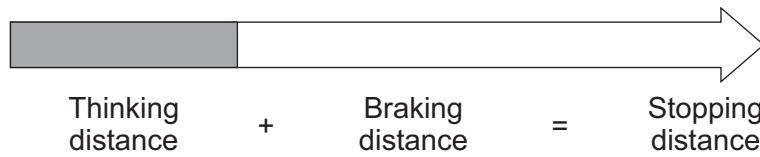

6 (a) Use words from the box to complete the sentence.

distance energy force time

The stopping distance is found by adding the distance the car travels during the driver's reaction and the distance the car travels under the braking

(2 marks)

6 (b) Which **one** of the following would **not** increase the thinking distance?

Tick (✓) **one** box.

- The car driver being tired.
- The car tyres being badly worn.
- The car being driven faster.

(1 mark)

6 (c) The graph shows how the braking distance of a car changes with the speed of the car. The force applied to the car brakes does not change.

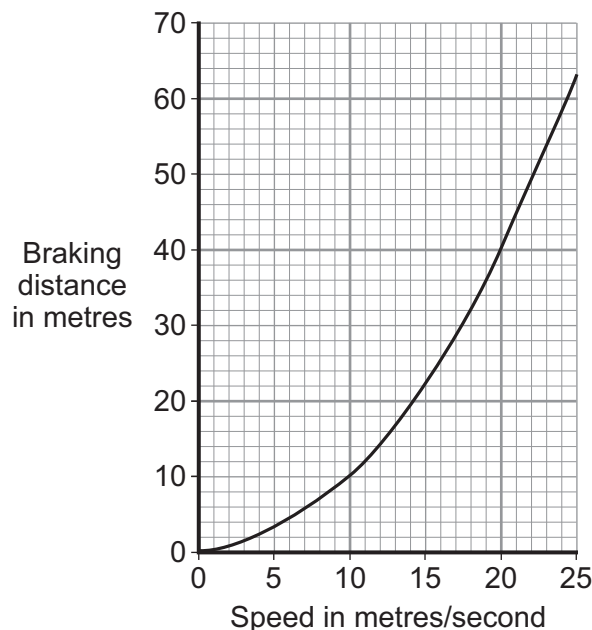

6 (c) (i) What conclusion about braking distance can be made from the graph?

.....
.....
.....
.....

(2 marks)

6 (c) (ii) The graph is for a car driven on a dry road.

Draw a line on the graph to show what is likely to happen to the braking distance at different speeds if the same car was driven on an icy road.

(1 mark)

6 (d) A local council has reduced the speed limit from 30 miles per hour to 20 miles per hour on a few roads. The reason for reducing the speed limit was to reduce the number of accidents.

6 (d) (i) A local newspaper reported that a councillor said:

“It will be much safer because drivers can react much faster when driving at 20 miles per hour than when driving at 30 miles per hour.”

This statement is wrong. Why?

.....
.....

(1 mark)

6 (d) (ii) The local council must decide whether to introduce the lower speed limit on a lot more roads.

What evidence should the local council collect to help make this decision?

.....
.....
.....
.....

(2 marks)



7 The diagram shows a boat pulling a water skier.

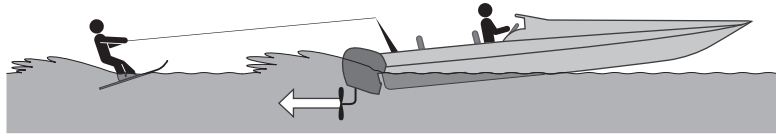

7 (a) The arrow represents the force on the water produced by the engine propeller. This force causes the boat to move.

Explain why.

.....
.....
.....
.....

(2 marks)

7 (b) The boat accelerates at a constant rate in a straight line. This causes the velocity of the water skier to increase from 4.0 m/s to 16.0 m/s in 8.0 seconds.

7 (b) (i) Calculate the acceleration of the water skier and give the unit.

Use the correct equation from the Physics Equations Sheet.

.....
.....
.....

Acceleration =

(3 marks)



7 (b) (ii) The water skier has a mass of 68 kg.

Calculate the resultant force acting on the water skier while accelerating.

Use the correct equation from the Physics Equations Sheet.

.....
.....
.....

Resultant force = N
(2 marks)

7 (b) (iii) Draw a ring around the correct answer to complete the sentence.

The force from the boat pulling the water skier forwards

will be

less than
the same as
greater than

 the answer to part (b)(ii).

Give the reason for your answer.

.....
.....

(2 marks)

9

Turn over for the next question

Turn over ►



8 (a) The diagram shows the circuit used to obtain the data needed to plot the current–potential difference graph for a filament bulb.

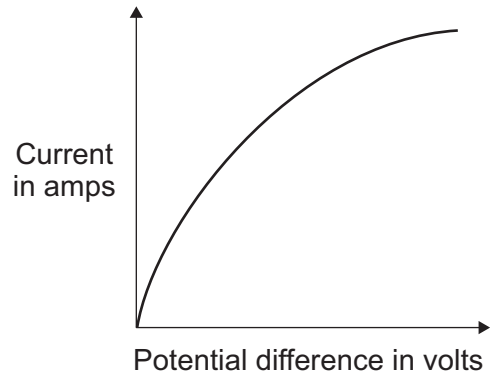
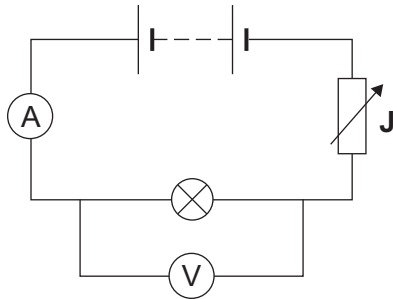

8 (a) (i) Why is the component labelled ‘J’ included in the circuit?

.....

(1 mark)

8 (a) (ii) The resistance of the bulb increases as the potential difference across the bulb increases. Why?

.....

(1 mark)

8 (a) (iii) The bulb is at full brightness when the potential difference across the bulb is 12V. The current through the bulb is then 3A.

Calculate the power of the bulb when it is at full brightness and give the unit.

Use the correct equation from the Physics Equations Sheet.

.....

Power =
 (3 marks)



- 8 (b)** *In this question you will be assessed on using good English, organising information clearly and using specialist terms where appropriate.*

The table gives data about two types of light bulb people may use in their homes.

Type of light bulb	Energy efficiency	Cost of one light bulb	Average lifetime in hours
Halogen	10%	£1.95	2 000
Light Emitting Diode (LED)	32%	£11.70	36 000

Both types of light bulb produce the same amount of light.

Evaluate, in terms of cost and energy efficiency, the use of the two types of light bulb.

To gain full marks you must compare both types of light bulb and conclude which light bulb would be the best to use.

.....

.....

.....

.....

.....

.....

.....

.....

.....

.....

.....

.....

.....

.....

.....

.....

.....

.....

.....

.....

.....

(6 marks)

11

END OF QUESTIONS



There are no questions printed on this page

**DO NOT WRITE ON THIS PAGE
ANSWER IN THE SPACES PROVIDED**

