

Centre Number						Candidate Number				
Surname										
Other Names										
Candidate Signature										

For Examiner's Use	
Examiner's Initials	
Question	Mark
1	
2	
3	
4	
5	
6	
7	
8	
9	
10	
TOTAL	



General Certificate of Secondary Education
Foundation Tier
June 2015

Chemistry

Unit Chemistry C3

CH3FP
F

Thursday 14 May 2015 9.00 am to 10.00 am

For this paper you must have:

- a ruler
 - the Chemistry Data Sheet (enclosed).
- You may use a calculator.

Time allowed

- 1 hour

Instructions

- Use black ink or black ball-point pen.
- Fill in the boxes at the top of this page.
- Answer **all** questions.
- You must answer the questions in the spaces provided. Do not write outside the box around each page or on blank pages.
- Do all rough work in this book. Cross through any work you do not want to be marked.

Information

- The marks for questions are shown in brackets.
- The maximum mark for this paper is 60.
- You are expected to use a calculator where appropriate.
- You are reminded of the need for good English and clear presentation in your answers.
- Question 10(b) should be answered in continuous prose. In this question you will be marked on your ability to:
 - use good English
 - organise information clearly
 - use specialist vocabulary where appropriate.

Advice

- In all calculations, show clearly how you work out your answer.



J U N 1 5 C H 3 F P O 1

G/KL/111147/Jun15/E4

CH3FP

Answer **all** questions in the spaces provided.

1 This question is about drinking water.

1 (a) The flow diagram in **Figure 1** shows how water is made suitable for drinking.

Figure 1

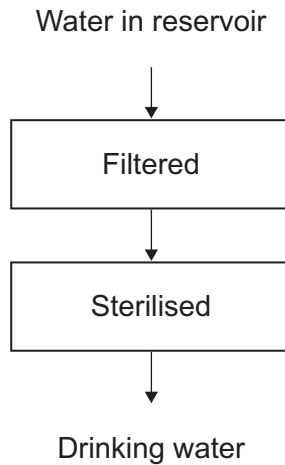

1 (a) (i) What is removed when the water is filtered?

[1 mark]

Tick (✓) **one** box.

Gases

Liquids

Solids



1 (a) (ii) What is used to sterilise the water?

[1 mark]

Tick (✓) **one** box.

Carbon

Chlorine

Sodium chloride

1 (a) (iii) Why is the water sterilised?

[1 mark]

.....
.....

1 (b) Water can be purified by distillation.

Drinking water is **not** usually purified by distillation because distillation is expensive.

Complete the sentence.

[1 mark]

Distillation is expensive because it requires a lot of

1 (c) Why do some water companies add fluoride to drinking water?

[1 mark]

.....
.....

5

Turn over for the next question

Turn over ►



There are no questions printed on this page

**DO NOT WRITE ON THIS PAGE
ANSWER IN THE SPACES PROVIDED**



- 3 A student investigates the energy released when zinc powder reacts with copper sulfate solution. The student uses the apparatus shown in **Figure 3**.

Figure 3

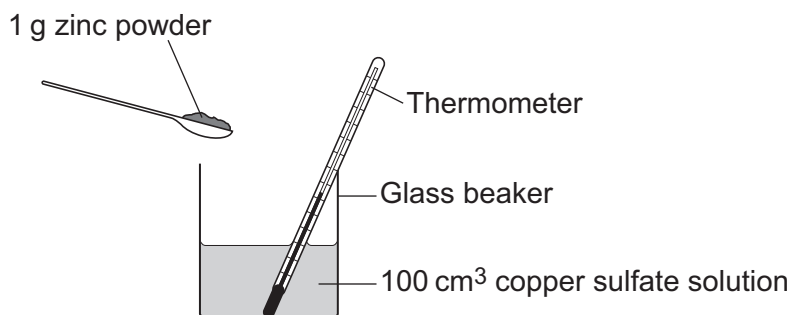

The student:

- measures 100 cm³ copper sulfate solution into a beaker
- measures the temperature of the copper sulfate solution
- puts 1 g zinc powder into the beaker
- stirs the mixture with a thermometer
- measures the highest temperature.

The student's results were:

Starting temperature = 21 °C

Highest temperature = 32 °C

- 3 (a) (i) Calculate the change in temperature.

[1 mark]

.....

Change in temperature = °C

- 3 (a) (ii) Calculate the energy released in the reaction.

Use the equation

$$\begin{array}{ccccccc} \text{energy released} & = & \text{volume of solution} & \times & 4.2 & \times & \text{temperature change} \\ \text{in J} & & \text{in cm}^3 & & & & \text{in } ^\circ\text{C} \end{array}$$

[2 marks]

.....

.....

Energy released = J



3 (b) The reaction of zinc with copper sulfate is exothermic.

How can you tell from the student's results that the reaction is exothermic?

[1 mark]

.....

.....

3 (c) The energy diagram for the reaction is shown in **Figure 4**.

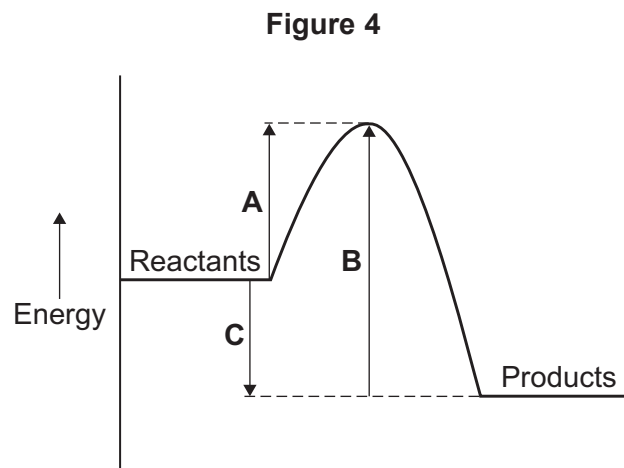

3 (c) (i) How can you tell from the energy diagram that the reaction is exothermic?

[1 mark]

.....

.....

3 (c) (ii) Which arrow shows the activation energy in **Figure 4**?

[1 mark]

Tick (✓) **one** box.

A

B

C



- 4 **Figure 5** shows a flow diagram of the Haber process.
The Haber process produces ammonia from nitrogen and hydrogen.

Figure 5

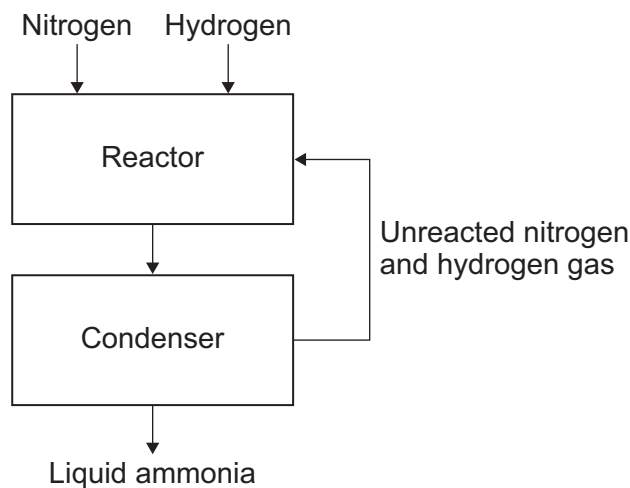

- 4 (a) Use the correct answer from the box to complete the sentence.

[1 mark]

air limestone natural gas

Hydrogen is obtained from

- 4 (b) In the reactor, nitrogen and hydrogen at a high pressure are heated and passed over a catalyst.

- 4 (b) (i) Use the correct answer from the box to complete the sentence.

[1 mark]

25 100 450

The temperature in the reactor is °C

- 4 (b) (ii) Use the correct answer from the box to complete the sentence.

[1 mark]

copper iron nickel

The catalyst used in the reactor is



4 (b) (iii) How does a catalyst speed up a reaction?

[1 mark]

Tick (✓) **one** box.

The catalyst lowers the activation energy.

The catalyst gives the reactants extra energy.

The catalyst increases the pressure in the reactor.

4 (c) A mixture of gases leaves the reactor.

The mixture contains ammonia, nitrogen and hydrogen.

Describe what happens to this mixture of gases in the condenser.

Use **Figure 5** to help you.

[3 marks]

.....

.....

.....

.....

.....

.....

7

Turn over for the next question

Turn over ►



5 This question is about organic compounds.

5 (a) Ethanol burns in air.

Use the correct answer from the box to complete the word equation for the reaction.

[1 mark]

carbon	hydrogen	oxygen
--------	----------	--------

ethanol + → carbon dioxide + water

5 (b) Use the correct answer from the box to complete the sentence.

[1 mark]

milk	hard water	vinegar
------	------------	---------

Ethanoic acid is in

5 (c) Ethanoic acid is a carboxylic acid.

Which diagram, **A**, **B** or **C**, has a ring around the functional group of a carboxylic acid?

Write your answer in the box.

[1 mark]

Diagram A

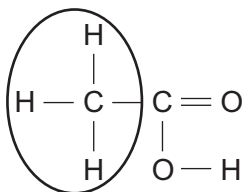

Diagram B

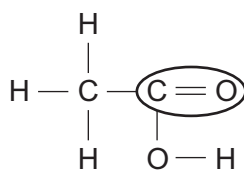
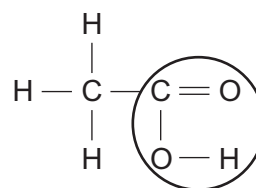

Diagram C



Diagram



5 (d) Ethyl propanoate is produced by reacting ethanol with propanoic acid.

What type of organic compound is ethyl propanoate?

[1 mark]

Tick (✓) **one** box.

Alcohol

Carboxylic acid

Ester

5 (e) Organic compounds such as ethyl propanoate are used in perfumes.

Give **two** properties of these compounds that make them suitable for use in perfumes.

[2 marks]

.....

.....

6

Turn over for the next question

Turn over ►



6 This question is about chemical tests.

6 (a) Solutions of copper(II) ions and iron(III) ions produce coloured precipitates with sodium hydroxide solution.

Draw **one** line from each metal ion to the colour of the precipitate it produces.

[2 marks]

Metal ion	Colour of precipitate
Copper(II) (Cu^{2+})	Blue
	Brown
	Green
Iron(III) (Fe^{3+})	White

6 (b) Sodium hydroxide solution was added to a solution containing ions of a metal.

A white precipitate was produced. The white precipitate dissolved in excess sodium hydroxide solution.

Use the correct answer from the box to complete the sentence.

[1 mark]

aluminium magnesium potassium

The ions in the solution were ions of



6 (c) Low sodium salt contains sodium chloride and potassium chloride.

A student used a flame test on low sodium salt.

6 (c) (i) What is the colour produced by sodium ions in a flame test?

[1 mark]

.....

6 (c) (ii) What is the colour produced by potassium ions in a flame test?

[1 mark]

.....

6 (c) (iii) Why is it **not** possible to tell from the flame test that both ions are present in low sodium salt?

[1 mark]

.....

.....

6

Turn over for the next question

Turn over ►



7 Some pollutants cause acid rain.

A student tested 25.0 cm³ samples of three types of rainwater, **P**, **Q** and **R**.
The student titrated the samples with sodium hydroxide solution (an alkali).

The student recorded the volume of sodium hydroxide solution needed to neutralise the rainwater. The student's results are shown in **Table 1**.

Table 1

Volume of sodium hydroxide needed to neutralise the rainwater in cm ³					
Type of rainwater	Titration 1	Titration 2	Titration 3	Titration 4	Mean value
P	18.0	15.5	14.5	15.0	15.0
Q	13.0	10.0	11.0	10.5	10.5
R	23.0	19.5	18.5	19.0	19.0

7 (a) (i) The student calculated the mean value for rainwater **R** as 19.0 cm³.

Show how the student calculated the mean value for rainwater **R**.

[2 marks]

.....

.....

.....

.....

7 (a) (ii) Write down **P**, **Q** and **R** in order of their acidity.

[2 marks]

Most acidic

.....

Least acidic



- 7 (b) A second student repeated the experiment and recorded the results in **Table 2**.

Table 2

Type of rainwater	Volume of sodium hydroxide needed to neutralise the rainwater in cm ³	
	Titration 1	Titration 2
P	17	15
Q	11	9
R	20	18

Use **Table 1** and **Table 2** to suggest **two** improvements the second student could make to obtain more accurate results.

[2 marks]

.....

.....

.....

.....

- 7 (c) The results of the two students show that the experiment is reproducible.

Give the reason why.

[1 mark]

.....

.....

7

Turn over for the next question

Turn over ►



8 In 1866 John Newlands produced an early version of the periodic table.

Part of Newlands' periodic table is shown in **Figure 6**.

Figure 6

Column	1	2	3	4	5	6	7
	H	Li	Be	B	C	N	O
	F	Na	Mg	Al	Si	P	S
	Cl	K	Ca	Cr	Ti	Mn	Fe

Newlands' periodic table arranged all the known elements into columns in order of their atomic weight.

Newlands was trying to show a pattern by putting the elements into columns.

8 (a) Iron (Fe) does **not** fit the pattern in column 7.

Give a reason why.

[1 mark]

.....

.....

8 (b) In 1869 Dmitri Mendeleev produced his version of the periodic table.

Why did Mendeleev leave gaps for undiscovered elements in his periodic table?

[1 mark]

.....

.....



8 (c) Newlands and Mendeleev placed the elements in order of atomic weight.

Complete the sentence.

[1 mark]

The modern periodic table places the elements in order of

8 (d) Lithium, sodium and potassium are all in Group 1 of the modern periodic table.

Explain why.

[2 marks]

.....
.....
.....
.....

5

Turn over for the next question

Turn over ►



There are no questions printed on this page

**DO NOT WRITE ON THIS PAGE
ANSWER IN THE SPACES PROVIDED**



9 This question is about the halogens (Group 7).

9 (a) How do the boiling points of the halogens change down the group from fluorine to iodine?

[1 mark]

.....
.....

9 (b) Sodium bromide is produced by reacting sodium with bromine.

Sodium bromide is an ionic compound.

9 (b) (i) Write down the symbols of the **two** ions in sodium bromide.

[1 mark]

.....

9 (b) (ii) Chlorine reacts with sodium bromide solution to produce bromine and one other product.

Complete the word equation for the reaction.

[1 mark]

chlorine + sodium bromide \longrightarrow bromine +

9 (b) (iii) Why does chlorine displace bromine from sodium bromide?

[1 mark]

.....
.....

9 (b) (iv) Use the Chemistry Data Sheet to help you to answer this question.

Suggest which halogen could react with sodium chloride solution to produce chlorine.

[1 mark]

.....

5

Turn over for the next question

Turn over ►



10 This question is about water.

10 (a) Rainwater is soft.

How is hard water produced from rainwater?

[2 marks]

.....

.....

.....

.....

10 (b) In this question you will be assessed on using good English, organising information clearly and using specialist terms where appropriate.

Hard water can be softened by two different methods.

Method 1: Ion exchange

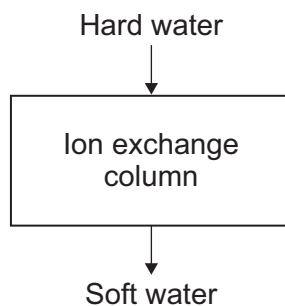

Method 2: Adding sodium carbonate (washing soda)

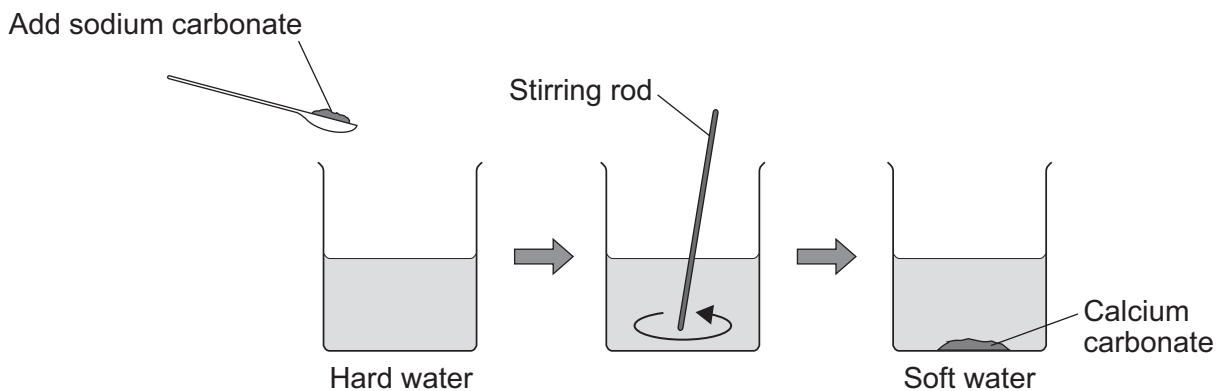

Describe how each method softens water **and** compare the advantages of these two methods.

[6 marks]

.....

.....

.....

.....

.....

.....

.....

.....

.....

.....

.....

.....

.....

.....

.....

.....

.....

.....

.....

.....

.....

.....

Extra space

.....

.....

.....

.....

.....

.....

.....

.....

.....

.....

.....

.....

.....

.....

.....

.....

.....

.....

.....

.....

.....

8

END OF QUESTIONS



There are no questions printed on this page

**DO NOT WRITE ON THIS PAGE
ANSWER IN THE SPACES PROVIDED**



There are no questions printed on this page

**DO NOT WRITE ON THIS PAGE
ANSWER IN THE SPACES PROVIDED**



There are no questions printed on this page

**DO NOT WRITE ON THIS PAGE
ANSWER IN THE SPACES PROVIDED**

